

C1/SFB (52.5) IH4

ALUTEC PRICE LIST

March 2011

**ALUTEC**  
ALUMINIUM RAINWATER SYSTEMS

PRICE LIST

100mm  
HARLEY ALUMINUM  
78mm  
6642

# CONTENTS

---

An Introduction to Alutec .....	3	Aligator .....	27
Product selector .....	4	Soffit & fascia .....	47
Evolve .....	5	Roof & floor .....	56
Traditional .....	15	General information .....	62

## ALUTEC RAINWATER COLOURS

---

Polyester powder coated range of RAL colours with 30% gloss finish that are available as standard (unless otherwise stated). Please quote the RAL number and colour reference with your order.



Additional colours, finishes and gloss levels are available, price on application. This chart is a representation of the actual colours, for exact match please ask for sample plates.

## ALUTEC SOFFIT, FASCIA AND COPING SYSTEM COLOURS

---



Colours are approximate and for general guidance only. For exact colour and finish reference, colour plates are available on request.

Additional colours are available subject to a minimum order quantity and lead time. For information on these and the gloss levels, please contact Customer Services, tel: 01234 359438.

# AN INTRODUCTION TO ALUTEC

---

## A provider of total eaves solutions

### NEW FOR 2011:

#### Evolve box gutter system:

Modern box profile with concealed top fixing brackets, with a maximum flow-rate of 7 l/s. It is the ideal solution for modern building designs or those where a very high flow-rate capacity is a pre-requisite.

#### Soffit, fascia and coping systems:

Only 4mm thick and made from a 100% recycled polyethylene core with aluminium bonded to each face. Available in 8 standard colours and with the same 50 year life expectancy as all Alutec systems.

#### Marine grade aluminium:

Alutec uses the highest quality marine grade aluminium throughout all its systems. This combination of marine grade aluminium and the highest quality architectural grade paint finish ensures the ultimate durability.

#### Roof drainage design

If your project is still on the drawing board, we can design the system for you, or simply advise if you wish. If your project is more advanced, we can provide a fully itemised estimate.

#### Standards

All Alutec products are manufactured in accordance with the appropriate British or European standards.

#### A free technical design and advisory service

Fast and efficient help with your queries, either by telephone or email.

Technical hotline: **01234 344108** or **technical@marleyalutec.co.uk**.



# PRODUCT SELECTOR CHART

## Choose the right downpipe.

Use the table below to select a compatible downpipe for your selected gutter profile.









		DOWNPIPES													
		Evolve 63 circular	102 x 76 rectangular	102 square	72 square	102 circular	63 circular	76 circular	Vandal resistant 72 sq, 102 x 76, 102 sq	72 Flush-fit square	76 Flush-fit circular	Alligator Classic 62 square	Alligator Classic 63 circular		
GUTTER SYSTEMS	Evolve	Half Round	✓												
		Deepflow							✓			✓			
		Box				✓			✓		✓	✓			
	Traditional	Half Round		✓	✓	✓	✓	✓	✓						
		Victorian Ogee		✓		✓		✓	✓						
		Moulded		✓	✓	✓	✓	✓	✓						
	Alligator	Classic											✓	✓	
		Deepflow		✓	✓	✓	✓	✓	✓	✓	✓	✓			
		No. 46		✓	✓	✓	✓	✓	✓	✓	✓	✓			
		Boxer		✓	✓	✓	✓	✓	✓	✓	✓	✓			
		Giant		✓	✓	✓	✓		✓	✓	✓	✓			

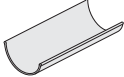



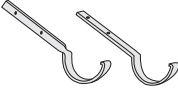
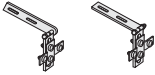

evolve

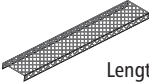
# RAINWATER SYSTEMS

## Evolve Half Round gutter – COMPATIBLE WITH EVOLVE 63MM DOWNPIPE (P7) ONLY

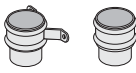
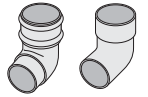

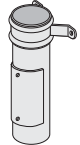

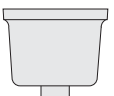

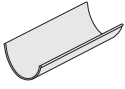

Description	Code	Heritage Black	PPC
<b>3M GUTTER</b> 123mm x 51mm 	GT513	47.25	54.06
<b>UNION</b> 	GT520	6.30	7.16
<b>FASCIA BRACKET</b> 	GT580	3.15	3.50
<b>ANGLES</b>  90° 135°	GT532 GT537	12.08 12.08	13.73 13.73
<b>RUNNING OUTLET</b>  63 Ø	GT522	17.33	19.61
<b>STOP ENDS</b>  Internal External	GT550 GT555	5.46 5.46	6.20 6.20
<b>FIXED RAFTER ARM</b>  Side Top	AT73 AT76	9.58 9.58	9.58 9.58
<b>ADJUSTABLE RAFTER ARM</b> Black Only  Side Top	AC78 AC77	7.65 7.65	
<b>RISE &amp; FALL BRACKET</b> 	AT93	10.99	10.99
<b>LEAF GUARD</b> Mill Finish  Length 1220mm	SL70	12.22	
<b>COMPATIBLE FIXING SCREWS</b> Roundhead fascia bracket screw 32mm x No 10 – Mill Finish	SC201	0.17	

FOR USE WITH EVOLVE HALF ROUND GUTTER (P6) ONLY – **Evolve 63mm downpipe**

Description	Code	Heritage Black	PPC
<b>3M DOWNPIPE</b> 	RT213	41.23	46.64
<b>PIPE SOCKETS</b>  Eared Uneared	RT220 RT220NE	8.22 8.22	9.28 9.28
<b>BENDS</b>  Top 112.5° Bottom 112.5° 92.5°	RT232 RT292 RT230	17.49 17.49 17.49	19.61 19.61 19.61
<b>BRANCH 112.5°</b> 	RT242	31.69	35.78
<b>SHOE</b> 	RT250	11.13	12.46
<b>ACCESS PIPE</b> 	RT260	34.72	38.96
<b>PIPE CLIP</b> 	RT280	2.92	3.18
<b>RAINWATER DIVERTER</b> 	RTD25	37.10	42.40
<b>HOPPER</b> 	RH110	43.39	43.39
<b>COMPATIBLE FIXING SCREWS</b> 50mm x No. 12 domehead – For use with downpipe 50mm x No. 16 domehead – For use with hopper	SC605 SC603	0.39 1.40	0.39 1.40

# RAINWATER SYSTEMS

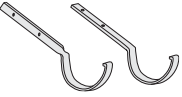
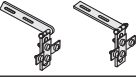
## Evolve Deepflow gutter

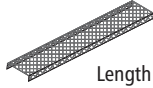
Description		Code	Heritage Black	PPC
<b>3M GUTTER</b> 128mm x 75mm		GE513	58.80	65.72
<b>UNION</b>		GE520	8.93	9.54
<b>FASCIA BRACKET</b>		GE580	3.94	4.45
<b>ANGLES</b>	 90° 135°	GE532 GE537	18.90 18.90	20.67 20.67
<b>RUNNING OUTLET</b>	 76 Ø	GE523	26.25	29.68
<b>STOP ENDS</b>	 Internal External	GE550 GE555	6.30 7.35	7.16 8.22
<b>FIXED RAFTER ARM</b>	 Side Top	AE73 AE76	10.35 10.35	10.35 10.35
<b>ADJUSTABLE RAFTER ARM</b> Black Only	 Side Top	AC78 AC77	7.65 7.65	
<b>RISE &amp; FALL BRACKET</b>		AE93	11.96	11.96
<b>LEAF GUARD</b> Mill Finish	 Length 1220mm	SL75	12.60	
<b>COMPATIBLE FIXING SCREWS</b> Roundhead fascia bracket screw	32mm x No 10 – Mill Finish	SC201	0.17	







# NEW

## WITH 7 l/s FLOW CAPACITY\*

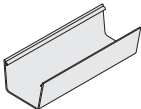
\*with 72mm square downpipe

# evolve

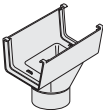
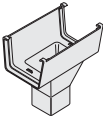

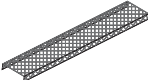





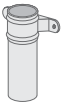

## Evolve Box gutter

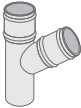
Description	Code	Heritage Black	PPC
<b>3M GUTTER</b> 130x85mm 	GB513	75.00	84.00
<b>UNION</b> 	GB520	14.75	15.25
<b>FASCIA BRACKET</b> 	GB580	4.65	4.85
<b>ANGLES</b>   90° 135°	GB532 GB537	29.00 22.00	31.00 23.00
<b>RUNNING OUTLETS</b>  76 Ø	GB523	38.00	39.50
<b>HIGH CAPACITY OUTLET – 7 l/s</b>  72x72mm	GB525	38.00	39.50
<b>STOP ENDS</b>   internal External	GB550 GB555	8.00 13.75	9.00 14.50
<b>LEAFGUARD</b> Mill Finish  Length 1220mm	SL76	12.89	
<b>COMPATIBLE FIXING SCREWS</b> Roundhead fascia bracket screw 32mm x No 10 – Mill Finish	SC201	0.17	

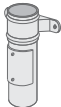

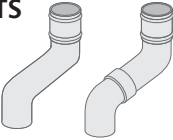





Heritage Black. Add the suffix H for Heritage Black to the product code when ordering. When ordering other colours, prefix code by 'X' and state colour and RAL number. PPC = Polyester Powder Coated supplied to our standard range of colours. When ordering PPC prefix code by 'X' and state colour and RAL number – see inside front cover.

# RAINWATER SYSTEMS

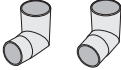
## 76mm Traditional circular downpipe



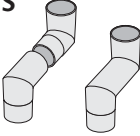





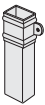

Description		Code	Heritage Black	PPC
<b>3M DOWNPIPE</b>	 ③	RR313	72.74	72.74
<b>LOOSE PIPE SOCKET</b>	 ③	RR320	14.18	14.18
<b>BENDS</b>	 92.5° 112.5°	RR330 RR332	41.28 26.54	41.28 26.54
<b>BRANCH 112.5°</b>		RR342	47.87	47.87
<b>SHOE</b>	 ③	RR350	20.47	20.47
<b>ACCESS PIPE</b>	 ③	RR360	52.26	52.26
<b>PIPE CLIP</b>		RR380	7.91	7.91
<b>OFFSETS</b>	 Fixed 75mm Fixed 100mm Fixed 150mm 2 part adj 200 to 450mm 2 part adj 200 to 900mm	RR3903 RR3904 RR3906 RR3945 RR3990	54.90 55.15 55.58 72.49 83.22	54.90 55.15 55.58 72.49 83.22
<b>RAINWATER DIVERTER</b>		RRD35	49.44	49.44
<b>HOPPER</b>		RH102	47.49	47.49
<b>COMPATIBLE FIXING SCREWS</b> 50mm x No. 16 domehead – for use with downpipe and hopper		SC603	1.40	1.40
<b>PIPE SOCKET FILLER</b> Foam	 10m roll	SC911	11.90	11.90

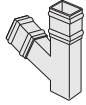
## 76mm Flush-fit circular downpipe



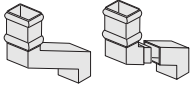

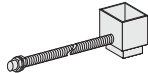





Description		Code	Heritage Black	PPC
<b>3M DOWNPIPE</b>		RE313	46.20	50.88
<b>LOOSE JOINT SPIGOT</b>		RE320	8.40	9.54
<b>BENDS</b>	 92.5° 112.5°	RE330 RE332	19.43 19.43	20.67 20.67
<b>BRANCH 112.5°</b>		RE342	36.75	38.16
<b>SHOE</b>		RE350	15.23	16.43
<b>ACCESS PIPE</b>		RE360	47.25	48.76
<b>PIPE CLIP</b>		RE380	3.68	3.98
<b>OFFSETS</b>	 2 part adj 90 to 250mm 2 part adj 90 to 500mm 2 part adj 90 to 1000mm Fixed	RE3925 RE3950 RE39100	42.00 44.50 49.50 POA	44.00 46.50 51.50 POA
<b>RAINWATER DIVERTER</b>		RED35	47.70	47.70
<b>HOPPER</b>		RH111	47.70	47.70
<b>COMPATIBLE FIXING SCREWS</b>				
50mm x No. 12 domehead – For use with downpipe		SC605	0.39	0.39
50mm x No. 16 domehead – For use with hopper		SC603	1.40	1.40

# RAINWATER SYSTEMS

## 72mm Traditional square downpipe

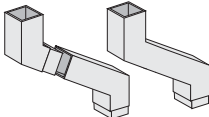
Description		Code	Heritage Black	PPC
<b>3M DOWNPIPE</b>		③		
Available with non eared sockets		RSR313	104.68	104.68
<b>LOOSE PIPE SOCKET</b>		③		
		RSR320	17.67	17.67
<b>BEND</b>		92.5° 112.5°		
		RSR330 RSR332	55.34 55.34	55.34 55.34
<b>BRANCH 112.5°</b>				
		RSR342	89.79	89.79
<b>SHOE</b>		③		
		RSR350	54.34	54.34
<b>ACCESS PIPE</b>		③		
		RSR360	62.25	62.25
<b>PIPE CLIP</b>		Two piece		
		RSR380	9.89	9.89
<b>OFFSETS</b>		Fixed – 75mm Fixed – 100mm Fixed – 150mm 2 part adj 75 to 450mm 2 part adj 75 to 900mm	RSR3903 RSR3904 RSR3906 RSR3945 RSR3990	67.97 68.63 69.95 95.87 104.05
Non Standard Projections Available				
<b>DRAIN CONNECTOR (SLIP SOCKET)</b>				
Adapts to 110mm Circular		RSR370	57.71	57.71
<b>RAINWATER DIVERTER KIT</b>				
Complete with black pvc-u flexible pipe		RSRD35	56.50	56.50
<b>HOPPER</b>		72x72mm		
		RH104	61.41	61.41
<b>COMPATIBLE FIXING SCREWS</b>				
50mm x No. 16 domehead – for use with downpipe and hopper		SC603	1.40	1.40

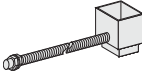



**NEW****evolve****72mm Flush-fit square downpipe**

Description		Code	Heritage Black	PPC
<b>3M DOWNPIPE</b>		RJ313	76.00	82.00
<b>LOOSE JOINT SPIGOT</b>		RJ320	8.25	9.25
<b>BENDS</b>	 92.5° 112.5°	RJ330 RJ332	28.25 28.25	28.75 28.75
<b>BRANCH 112.5°</b>		RJ342	48.00	49.00
<b>SHOE</b>		RJ350	19.25	19.75
<b>ACCESS PIPE</b>		RJ360	34.00	35.00
<b>PIPE CLIP 72MM</b>	 Two piece	RJ380	8.00	9.00
<b>OFFSETS</b>	 2 part adj 75 to 250mm 2 part adj 75 to 500mm 2 part adj 75 to 1000mm Fixed	RJ3925 RJ3950 RJ39100	58.00 63.00 73.00 POA	59.00 64.00 74.00 POA
<b>DRAIN CONNECTOR (SLIP SOCKET)</b>		RJ370	56.70	56.70
<b>RAINWATER DIVERTER</b>		RSRD35	56.50	56.50
<b>HOPPER</b>	 72 x 72mm	RH112	61.41	61.41
<b>COMPATIBLE FIXING SCREWS</b>	50mm x 12 roundhead – for use with downpipe 50mm x No. 16 domehead – for use with hopper	SC605 SC603	0.39 1.40	0.39 1.40

Heritage Black. Add the suffix H for Heritage Black to the product code when ordering. When ordering other colours, prefix code by 'X' and state colour and RAL number. PPC = Polyester Powder Coated supplied to our standard range of colours. When ordering PPC prefix code by 'X' and state colour and RAL number – see inside front cover.

# RAINWATER SYSTEMS

## Evolve installation sundries

Description	Code	Price
<p><b>SEALANT</b></p>  <p>310ml clear Please note sealant shelf life is 12 months</p>	SC101	7.11
<p><b>SEALANT GUN</b></p> 	SC105	12.59
<p><b>SOLVENT CLEANER</b></p>  <p>1 litre</p>	SC108	23.26
<p><b>TOUCH UP PAINT</b></p>  <p>250ml</p>	SC880	29.04

## Evolve sealant usage table

Approximate number of joints per tube of Alutec sealant

Half round .....	30
Deepflow .....	30
Box .....	30
76mm dia. pipe socket .....	20
72 x 72mm pipe socket .....	17

310ml Tube of sealant = approximately 6 linear metres of 8mm diameter bead.





Now all  
BS 8530: 2010  
compliant

A black and white photograph of several water droplets of varying sizes resting on a leaf. The droplets are in sharp focus, showing reflections and refractions. The leaf's vein structure is visible. The background is dark and out of focus.



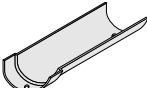

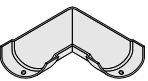

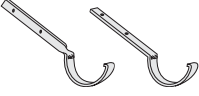

traditional

# RAINWATER SYSTEMS

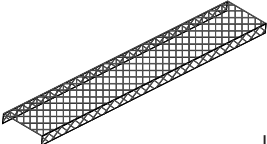
## Traditional Half Round Gutter System





Description	100mm (4")			113mm (4½")			125mm (5")			
	Code	Mill	PPC	Code	Mill	PPC	Code	Mill	PPC	
<b>GUTTER</b>										
 1.83m	GC406	25.53	39.36	GC106	28.22	41.00	GC506	30.85	45.92	
<b>UNION CLIP</b>										
 (external)	GC420	5.90	7.30	GC120	6.26	7.86	GC520	7.29	8.69	
<b>FASCIA BRACKET</b>										
	GC480	2.14	3.13	GC180	2.22	3.27	GC580	4.06	5.17	
<b>ANGLES</b>										
 90°	GC432	9.59	12.47	GC132	11.01	14.27	GC532	13.07	15.94	
135°	GC437	25.73	29.62	GC137	27.14	31.45	GC537	30.23	33.05	
non std angle ①	GC439	POA	POA	GC139	POA	POA	GC539	POA	POA	
<b>OUTLET</b>										
 63mm Ø	GC422	16.31	19.60	GC122	14.67	18.18	GC522	15.57	18.44	
76mm Ø	GC423	16.31	19.60	GC123	14.67	18.18	GC523	15.57	18.44	
102mm Ø							GC524	20.69	23.54	
72x72mm	GC425	36.37	40.94	GC125	34.77	39.49	GC525	36.92	39.75	
102x76mm							GC526	42.96	45.80	
<b>STOP END</b>										
 Stop end int	GC450	3.60	5.46	GC150	4.04	6.03	GC550	4.70	7.08	
Stop end ext	GC455	3.60	5.46	GC155	4.04	6.03	GC555	4.70	7.08	





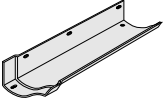

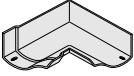
## Traditional Half Round Gutter System

Description		Code	Mill	PPC
<b>FIXED RAFTER ARM</b>  	Side 100mm	AC71	8.36	9.58
	Side 113mm	AC72	8.36	9.58
	Side 125mm	AC73	8.36	9.58
	Top 100mm	AC74	8.36	9.58
	Top 113mm	AC75	8.36	9.58
	Top 125mm	AC76	8.36	9.58
	<b>RISE &amp; FALL BRACKET</b>  	100mm	AC91	
113mm		AC92		10.99
125mm		AC93		11.18
<b>HEAVY DUTY LEAFGUARD</b>    Mill Finish <span style="float: right;">Length: 1220mm</span>	100mm	SL71	12.89	
	113mm	SL72	12.89	
	125mm	SL73	12.89	
	<b>COMPATIBLE FIXING SCREWS</b>			
Roundhead fascia bracket screw				
 32mm x No 10 – Mill Finish		SC201	0.17	
<b>POLYESTER POWDER COATED BOLTS</b>				
 <span style="float: right;">M6 x 20mm Aluminium bolt PPC</span>		SC602		0.29
<b>ALUMINIUM NUTS, BOLTS &amp; WASHERS MILL</b>				
 <span style="float: right;">M6 x 20mm Aluminium bolt per 100</span>		SC502	14.87	
 <span style="float: right;">M6 Aluminium nut per 100</span>		SC511	15.06	
 <span style="float: right;">M6 x 15mm Aluminium washer per 100</span>		SC521	7.53	

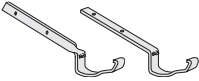
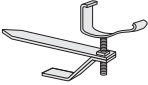
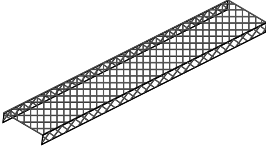
# RAINWATER SYSTEMS







## Victorian Ogee Gutter System

Description	100mm (4")			113mm (4½")			125mm (5")		
	Code	Mill	PPC	Code	Mill	PPC	Code	Mill	PPC
<b>GUTTER</b>									
 1.83m	GV406	44.43	59.30	GV106	59.39	77.02	GV506	62.95	81.54
<b>UNION CLIP</b>									
 (external)	GV420	6.36	8.47	GV120	8.40	11.00	GV520	11.50	14.34
<b>FASCIA BRACKET</b>									
	GV480	5.97	7.37	GV180	8.27	10.00	GV580	9.20	10.72
<b>ANGLES</b>									
 90° int	GV430	11.94	16.44	GV130	18.34	23.14	GV530	20.67	25.20
90° ext	GV431	11.94	16.44	GV131	18.34	23.14	GV531	20.67	25.20
135° int	GV435	11.94	14.78	GV135	18.34	21.83	GV535	41.83	46.81
135° ext	GV436	11.94	14.78	GV136	18.34	21.83	GV536	41.83	46.81
non std angle ①	GV439	POA	POA	GV139	POA	POA	GV539	POA	POA
<b>OUTLET</b>									
 63mm Ø	GV422	20.24	24.63	GV122	20.24	25.05	GV522	27.57	33.02
76mm Ø	GV423	20.24	24.63	GV123	20.24	25.05	GV523	27.57	33.02
72x72mm	GV425	58.83	65.82	GV125	58.83	66.04	GV525	66.15	73.97
102x76mm							GV526	66.15	73.97
<b>STOP END</b>									
 Left Hand (int)	GV450	6.45	7.96	GV150	8.27	10.14	GV550	11.50	13.73
Right Hand (ext)	GV455	6.45	7.99	GV155	8.27	10.25	GV555	11.50	13.80

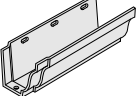



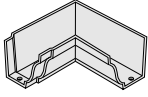
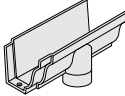

Description		Code	Mill	PPC
<b>FIXED RAFTER ARM</b>				
	Side 100mm	AV71	9.58	10.80
	Side 113mm	AV72	9.58	10.80
	Side 125mm	AV73	9.58	10.80
	Top 100mm	AV74	9.58	10.80
	Top 113mm	AV75	9.58	10.80
	Top 125mm	AV76	9.58	10.80
<b>RISE &amp; FALL BRACKET</b>				
	100mm	AV91		16.80
	113mm	AV92		16.80
	125mm	AV93		16.80
<b>HEAVY DUTY LEAFGUARD</b>				
	100mm	SL111	12.89	
	113mm	SL113	12.89	
	125mm	SL125	12.89	
Mill Finish	Length: 1220mm			
<b>COMPATIBLE FIXING SCREWS</b>				
Roundhead fascia bracket screw				
		SC201	0.17	
32mm x No 10 – Mill Finish				
<b>POLYESTER POWDER COATED BOLTS</b>				
	M6 x 20mm Aluminium bolt PPC	SC602		0.29
<b>ALUMINIUM NUTS, BOLTS &amp; WASHERS PLAIN</b>				
	M6 x 20mm Aluminium bolt per 100	SC502	14.87	
	M6 Aluminium nut per 100	SC511	15.06	
	M6 x 15mm Aluminium washer per 100	SC521	7.53	

# RAINWATER SYSTEMS

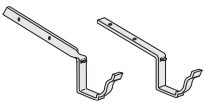
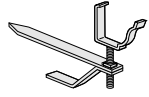
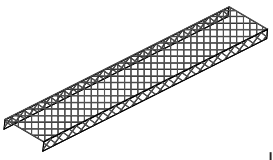
## Moulded Ogee Gutter System







Description	100x75mm (4x3")			125x100mm (5x4")			150x100mm (6x4")			
	Code	Mill	PPC	Code	Mill	PPC	Code	Mill	PPC	
<b>GUTTER</b> 	1.83m	GM406	90.38	106.39	GM506	72.16	91.41	GM606	118.93	140.00
<b>UNION CLIP</b> 		GM420	11.81	13.90	GM520	11.42	13.65	GM620	21.97	25.86
<b>FASCIA BRACKET</b> 		GM480	9.68	11.41	GM580	9.29	10.74	GM680	15.83	18.63
<b>DIRECT FIX BRACKET</b> 		GM481	3.71	4.90	GM581	3.71	4.90	GM681	3.71	4.90
<b>ANGLES</b> 	90° int	GM430	21.62	25.44	GM530	22.14	27.84	GM630	35.59	41.90
	90° ext	GM431	21.62	25.44	GM531	22.14	27.84	GM631	35.59	41.90
	135° int	GM435	21.62	25.44	GM535	22.14	27.84	GM635	35.59	41.90
	135° ext	GM436	21.62	25.44	GM536	22.14	27.84	GM636	35.59	41.90
	non std angle ①	GM439	POA	POA	GM539	POA	POA	GM639	POA	POA
<b>OUTLET</b> 	63mm Ø	GM422	26.77	31.51	GM522	22.14	28.40	GM622	56.22	66.17
	76mm Ø	GM423	26.77	31.51	GM523	22.14	28.40	GM623	56.22	66.17
	102mm Ø				GM524	60.76	70.88	GM624	56.22	66.17
	72x72mm	GM425	38.05	44.80	GM525	22.14	28.40	GM625	86.49	101.82
	102x76mm	GM426	38.05	44.80	GM526	60.76	70.88	GM626	86.49	101.82
	102x102mm				GM527	61.02	71.14	GM627	86.49	101.82
<b>STOP END</b> 	Left Hand (ext)	GM450	11.25	13.23	GM550	11.91	14.75	GM650	21.97	25.86
	Right Hand (int)	GM455	11.25	13.23	GM555	11.91	14.75	GM655	21.97	25.86

## Moulded Ogee Gutter System

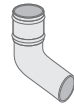

Description	Code	Mill	PPC
<b>FIXED RAFTER ARM</b>  Side 100x75mm Side 125x100mm Side 150x100mm Top 100x75mm Top 125x100mm Top 150x100mm	AM71 AM73 AM75 AM74 AM76 AM77	10.80 10.80 10.80 10.80 10.80 10.80	12.00 12.00 12.00 12.00 12.00 12.00
<b>RISE &amp; FALL BRACKET</b>  100x75mm 125x100mm 150x100mm	AM91 AM93 AM94		16.80 16.80 16.80
<b>HEAVY DUTY LEAFGUARD</b>  100x75mm 125x100mm 150x100mm Mill Finish Length: 1220mm	SL114 SL115 SL116	12.89 12.89 12.89	
<b>COMPATIBLE FIXING SCREWS</b> Roundhead fascia bracket screw  32mm x No 10 – Mill Finish	SC201	0.17	
<b>POLYESTER POWDER COATED BOLTS</b>  M6 x 20mm Aluminium bolt PPC	SC602		0.29
<b>ALUMINIUM NUTS, BOLTS &amp; WASHERS PLAIN</b>  M6 x 20mm Aluminium bolt per 100  M6 Aluminium nut per 100  M6 x 15mm Aluminium washer per 100	SC502 SC511 SC521	14.87 15.06 7.53	

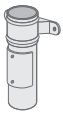

# RAINWATER SYSTEMS

## Circular Downpipe Systems

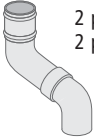
Description	63mm			76mm			102mm			
	Code	Mill	PPC	Code	Mill	PPC	Code	Mill	PPC	
<b>PIPE</b> 	1m ③	RR211	29.84	33.91	RR311	33.13	38.19	RR411	48.85	56.70
	2m ③	RR212	41.08	50.42	RR312	45.76	56.87	RR412	68.78	86.05
	3m ③	RR213	49.15	63.97	RR313	55.42	72.74	RR413	85.30	112.32
	Available with non eared socket ③									
<b>LOOSE PIPE SOCKET</b> 	③	RR220	9.04	10.62	RR320	12.30	14.18	RR420	19.29	22.42
<b>BEND</b> 	Bend 92.5°	RR230	34.78	36.57	RR330	39.10	41.28	RR430	56.08	60.01
	Bend 112.5°	RR232	18.74	20.88	RR332	23.93	26.54	RR432	29.66	33.83
	Bend 135°	RR235	27.13	28.90	RR335	44.03	47.07	RR435	54.51	59.03
<b>BRANCHES</b> 	Branch 92.5°	RR240	38.92	41.13	RR340	44.72	47.87	RR440	60.13	65.35
	Branch 112.5°	RR242	37.22	41.13	RR342	44.72	47.87	RR442	60.13	65.35
	Branch 135°	RR245	38.92	41.13	RR345	44.72	47.87	RR445	57.26	65.35
<b>SHOE</b> 	③	RR250	12.97	14.33	RR350	17.92	20.47	RR450	23.67	27.76
<b>ACCESS PIPE</b> 	③	RR260	42.57	44.73	RR360	49.26	52.26	RR460	57.77	62.78
<b>PIPE CLIP</b> 	One Piece	RR280	6.35	7.58	RR380	6.42	7.91	RR480	7.50	8.95
<b>FIXED OFFSETS</b> 	75mm	RR2903	42.74	44.45	RR3903	52.58	54.90	RR4903	63.95	67.57
	100mm	RR2904	42.74	44.68	RR3904	52.58	55.15	RR4904	63.95	67.89
	150mm	RR2906	42.74	45.01	RR3906	52.58	55.58	RR4906	63.95	68.39
	225mm	RR2909	51.30	54.57	RR3909	62.26	67.35	RR4909	74.60	80.63
	300mm	RR2912	51.30	55.11	RR3912	63.09	68.09	RR4912	74.60	81.71
Non Standard Projections Available										



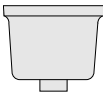
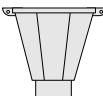
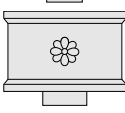



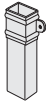

## Circular Downpipe Systems

Description	63mm			76mm			102mm		
	Code	Mill	PPC	Code	Mill	PPC	Code	Mill	PPC
<b>ADJUSTABLE OFFSETS</b>									
 2 part adj to 450mm 2 part adj to 900mm	RR2945	54.52	58.92	RR3945	67.06	72.49	RR4945	91.52	100.31
	RR2990	58.88	65.36	RR3990	75.24	83.22	RR4990	105.14	117.96
Non Standard Projections Available	Min Offset Achievable 150mm			Min Offset Achievable 200mm			Min Offset Achievable 160mm		
<b>RAINWATER DIVERTER KIT</b>									
	RRD25	42.37	44.73	RRD35	47.09	49.44			
Complete with black pvc-u flexible pipe									

Description	Code	Mill	PPC
<b>HOPPERS</b>			
 Standard – 63mm Circular Standard – 76mm Circular Standard – 102mm Circular	RH101	36.85	45.77
	RH102	38.54	47.49
	RH103	51.59	61.41
 Triangular Flat Back – 63 mm Circular Triangular Flat Back – 76 mm Circular	RH201	25.75	35.37
	RH202	25.75	35.37
 Ornamental – 63mm Circular Ornamental – 76mm Circular Ornamental – 102mm Circular	RH301	173.42	187.87
	RH302	173.42	187.87
	RH303	173.42	187.87
<b>PIPE SOCKET FILLER</b>			
Foam  10m roll	SC911	11.90	
<b>CAST SPACER BOBBIN</b>			
30mm projection  PPC Mill Finish	SC711 SC701	4.63	5.33
<b>COMPATIBLE FIXING SCREWS</b>			
50mm x No. 16 domehead – for use with downpipe & hopper	SC603		1.40
50mm x No. 16 domehead – for use with downpipe & hopper	SC221	1.24	
75mm x No. 16 hexagonal – for use with Cast spacer bobbin	SC604		1.24
75mm x No. 16 hexagonal – for use with Cast spacer bobbin	SC244	1.14	

# RAINWATER SYSTEMS



## Square & Rectangular Downpipe Systems



Description	72x72mm			102x76mm			102x102mm			
	Code	Mill	PPC	Code	Mill	PPC	Code	Mill	PPC	
<b>PIPE</b> 	1m ③	RSR311	46.33	52.79	RSR111	58.52	66.39	RSR411	54.79	63.22
	2m ③	RSR312	65.36	80.44	RSR112	87.54	105.62	RSR412	80.23	99.55
	3m ③	RSR313	80.78	104.68	RSR113	112.80	141.39	RSR413	102.37	132.93
	Available with non eared sockets ③									
<b>LOOSE PIPE SOCKET</b> 	③	RSR320	15.59	17.67	RSR120	17.44	19.83	RSR420	17.68	20.88
<b>BEND</b> 	92.5°	RSR330	52.41	55.34	RSR130④	58.72	63.11	RSR430	58.13	61.72
	112.5°	RSR332	52.41	55.34	RSR132④	58.72	63.11	RSR432	58.13	61.72
	135°	RSR335	52.41	55.34	RSR135④	58.72	63.11	RSR435	58.13	61.72
	See note 4 for handing									
<b>BRANCHES</b> 	92.5°	RSR340	82.31	89.79	RSR140④	92.90	98.91	RSR440	90.94	95.53
	112.5°	RSR342	82.31	89.79	RSR142④	92.90	98.91	RSR442	90.94	95.53
	135°	RSR345	82.31	89.79	RSR145④	92.90	98.91	RSR445	90.94	95.53
	See note 4 for handing									
<b>SHOE</b> 	③	RSR350	52.41	54.34	RSR150	58.72	61.33	RSR450	58.13	61.32
<b>ACCESS PIPE</b> 	③	RSR360	59.40	62.25	RSR160	64.63	68.44	RSR460	61.07	65.71
<b>PIPE CLIP</b> 	Two piece	RSR380	9.18	9.89	RSR180	8.00	8.87	RSR480	8.22	9.44
<b>FIXED OFFSETS</b> 	75mm	RSR3903	65.34	67.97	RSR1903④	71.96	75.25	RSR4903	69.66	81.08
	100mm	RSR3904	65.99	68.63	RSR1904④	72.65	76.20	RSR4904	71.02	83.87
	150mm	RSR3906	66.56	69.95	RSR1906④	73.44	77.57	RSR4906	73.81	87.79
	225mm	RSR3909	67.61	71.73	RSR1909④	74.90	79.60	RSR4909	75.37	89.65
	300mm	RSR3912	68.80	73.64	RSR1912④	76.39	82.20	RSR4912	76.86	92.30
	Non Standard Projections Available									
See note 4 for handing										

PPC = Polyester Powder Coated supplied to our standard range of colours. When ordering, PPC prefix code by 'X' and state colour and RAL number – see inside front cover.

④ = For 102 x 76mm state if different handing/projection is required, otherwise will be supplied as illustrated.

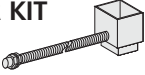

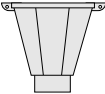
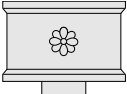

## Square & Rectangular Downpipe Systems

Description	72x72mm			102x76mm			102x102mm		
	Code	Mill	PPC	Code	Mill	PPC	Code	Mill	PPC
<b>ADJUSTABLE OFFSETS</b>									
 2 part adj to 450mm	RSR3945	90.98	95.87	RSR1945④	99.37	105.32	RSR4945	95.98	103.08
2 part adj to 900mm	RSR3990	95.83	104.05	RSR1990④	105.67	115.49	RSR4990	102.73	114.37
	See note 4 for handling								
Non Standard Projections Available	Min Offset Achievable 75mm			Min Offset Achievable 75mm			Min Offset Achievable 100mm		
<b>DRAIN CONNECTOR (SLIP SOCKET)</b>									
 RSR370	RSR370	55.89	57.71	RSR170	57.66	60.11	RSR470	59.42	62.71
Adapts to 110mm Circular									
<b>RAINWATER DIVERTER KIT</b>									
 RSRD35	RSRD35	54.14	56.50	RSRD15	61.20	63.57			
Complete with black pvc-u flexible pipe									

Description	Code	Mill	PPC
<b>HOPPERS</b>			
 Standard – 72x72mm	RH104	51.59	61.41
Standard – 102x76mm	RH105	51.59	61.41
Standard – 102x102mm	RH106	51.59	61.41
 Triangular Flat Back – 72x72mm	RH204	57.10	67.60
 Ornamental – 72x72mm	RH304	173.42	187.87
Ornamental – 102x76mm	RH305	173.42	187.87
Ornamental – 102x102mm	RH306	173.42	187.87
<b>CAST SPACER BOBBIN</b>			
 30mm projection	PPC SC711 Mill Finish SC701	4.63	5.33
<b>COMPATIBLE FIXING SCREWS</b>			
50mm x No. 16 domehead – for use with downpipe & hopper	SC603		1.40
50mm x No. 16 domehead – for use with downpipe & hopper	SC221	1.24	
75mm x No. 16 hexagonal – for use with Cast spacer bobbin	SC604		1.24
75mm x No. 16 hexagonal – for use with Cast spacer bobbin	SC244	1.14	

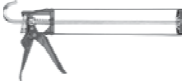
# RAINWATER SYSTEMS

## Traditional installation sundries

Description		Code	Price
<b>SEALANT</b>   310ml clear Please note sealant shelf life is 12 months		SC101	7.11
<b>SEALANT GUN</b>  		SC105	12.59
<b>SOLVENT CLEANER</b>    1 litre		SC108	23.26
<b>TOUCH UP PAINT</b>    250ml		SC880	29.04
<b>LIGHTNING CONDUCTOR</b>  	Universal link assembly Oxide inhibitor 225cc	SC401 SC402	6.37 63.08

## Traditional sealant usage table

Approximate number of joints per tube of Alutec sealant

100mm half round .....	18	63mm dia. pipe socket .....	25
113mm half round .....	16	76mm dia. pipe socket .....	20
125mm half round .....	14	102mm dia. pipe socket .....	15
100mm Victorian Ogee .....	14	72 x 72mm pipe socket .....	17
113mm Victorian Ogee .....	12	102 x 76mm pipe socket .....	13
125mm Victorian Ogee .....	11	102 x 102mm pipe socket .....	12
100mm Moulded .....	11		
125mm Moulded .....	9		
150mm Moulded .....	7		

## Coming soon

New range of conservation  
downpipes and hoppers.

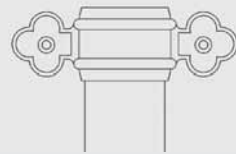

310ml Tube of sealant = approximately 6 linear metres of 8mm diameter bead.







aligator

# RAINWATER SYSTEMS

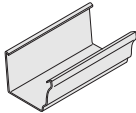

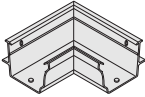
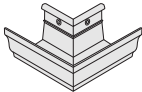
## Aligator® snap fit Classic –

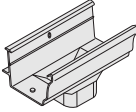
COMPATIBLE WITH CLASSIC 63MM CIRCULAR AND 62MM SQUARE PIPES (P30/31) ONLY

Description		Code	Heritage Black	PPC	
<b>GUTTER</b>					
120x75mm ogee style		3m	GK413	38.25	60.02
<b>UNION</b>					
			GK420	5.57	7.12
<b>FASCIA BRACKET</b>					
		(external)	GK480	3.52	4.43
<b>ANGLES</b>					
		90° int	GK430	25.64	30.79
		90° int	GK431	25.64	30.79
		135° int	GK435	25.64	30.7
		135° ext	GK436	25.64	30.79
Special angles available on request					
<b>RUNNING OUTLET</b>					
		63mm Ø 62 x 62mm	GK421	30.61	42.06



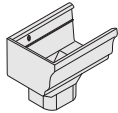
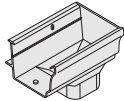

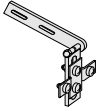
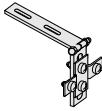
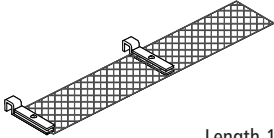

COMPATIBLE WITH CLASSIC 63MM CIRCULAR  
AND 62MM SQUARE PIPES (P30/31) ONLY

– Aligator® snap fit Classic

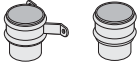
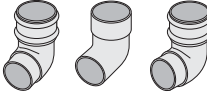
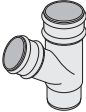

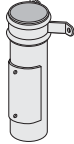

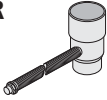
Description		Code	Heritage Black	PPC
<b>STOP END OUTLET</b>	 LH	GK428	42.76	57.07
<b>STOP END OUTLET</b>	 RH	GK429	42.76	57.07
<b>STOP END</b>	 LH	GK450	5.97	7.44
<b>STOP END</b>	 RH	GK455	5.97	7.44
<b>ADJUSTABLE RAFTER ARM</b>	  Side Top	AC78 AC77	7.65 7.65	
Available in black only				
<b>HEAVY DUTY LEAFGUARD</b>		SL101	12.89	
Mill finish	Length 1220mm			
<b>COMPATIBLE FIXING SCREWS</b>	32mm x No. 10 roundhead – for use with gutter 32mm x No. 10 countersunk – for use with union, angle and outlet Mill finish	SC201 SC202	0.17 0.17	

# RAINWATER SYSTEMS

**Aligator® Classic 63mm circular** – FOR USE WITH ALIGATOR® CLASSIC GUTTER (P28) ONLY

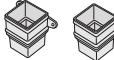
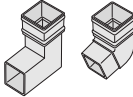
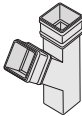
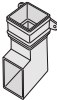
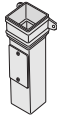

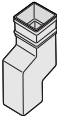

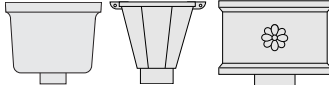

Description	Code	Heritage Black	PPC
<b>3M DOWNPIPE</b> 	RT213	41.23	46.64
<b>PIPE SOCKETS</b>  Eared Un-eared	RT220 RT220NE	8.22 8.22	9.28 9.28
<b>BENDS</b>  Top 112.5° Bottom 112.5° 92.5°	RT232 RT292 RT230	17.49 17.49 17.49	19.61 19.61 19.61
<b>BRANCH 112.5°</b> 	RT242	31.69	35.78
<b>SHOE</b> 	RT250	11.13	12.46
<b>ACCESS PIPE</b> 	RT260	34.72	38.96
<b>PIPE CLIP</b> 	RT280	2.92	3.18
<b>RAINWATER DIVERTER</b> 	RTD25	37.10	42.40
<b>HOPPERS</b>  Standard	RH110	43.39	43.39
<b>COMPATIBLE FIXING SCREWS</b> 50mm x No. 16 domehead – For use with hopper 50mm x No. 12 domehead – For use with downpipe	SC603 SC605	1.40 0.39	1.40 0.39

FOR USE WITH ALIGATOR® CLASSIC GUTTER (P28) ONLY – **Aligator® Classic 62mm square**

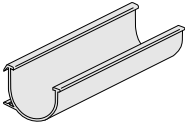
Description	Code	Heritage Black	PPC
<b>3M DOWNPIPE</b> 	RK313	42.47	51.81
<b>SOCKETS</b>  Eared Unearred	RK320 RK320NE	7.58 7.58	8.28 8.28
<b>BENDS</b>  92.5° 112.5°	RK330 RK332	22.87 10.49	24.43 11.42
<b>BRANCH</b>  112.5°	RK342	42.76	45.06
<b>SHOE</b> 	RK350	23.34	24.79
<b>ACCESS PIPE</b> 	RK360	28.99	32.30
<b>PIPE CLIP</b> one piece 	RK380	3.14	3.46
<b>WALL OFFSET</b>  50mm offset	RK3902	31.75	33.79
<b>RAINWATER DIVERTER KIT</b>  only available in PVCu	RK25B (black) RK25W (white)	35.99 35.99	
<b>HOPPERS</b>  Standard Triangular Flat Back Ornamental	RH100 RH200 RH300	51.59 57.10 173.42	61.41 67.60 187.87
<b>POLYESTER POWDER COATED PIPE SCREWS</b> 50mm x No. 16 domehead – for use with hopper 50mm x No. 12 domehead – for use with downpipe	SC603 SC605	1.40 0.39	1.40 0.39

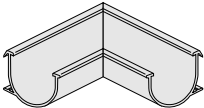
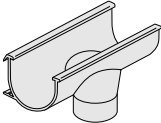

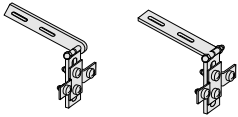

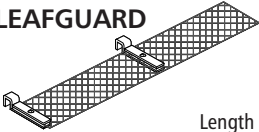

# RAINWATER SYSTEMS

## Aligator® snap fit Deepflow

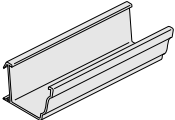
Description		Code	Mill	PPC	
<b>GUTTER</b> 130x80mm Deep half round		1m	GD511	35.79	38.13
		2m	GD512	69.14	74.27
		3m	GD513	99.99	108.28
<b>UNION CLIP</b>	 (internal)	GD520	3.71	5.19	
<b>FASCIA BRACKET</b>	 ②	GD580	1.36	2.34	
<b>ANGLES</b>	 non std angle ①	90° int	GD530	35.32	40.55
		90° ext	GD531	35.32	40.55
		135° int	GD535	35.32	40.55
		135° ext	GD536	35.32	40.55
			GD539	POA	POA
<b>OUTLET</b>		63mm Ø	GD522	26.86	31.03
		76mm Ø	GD523	29.53	33.70
		102mm Ø	GD524	48.52	52.67
		72x72mm	GD525	36.08	40.26
		102x76mm	GD526	44.35	48.52
		102x102mm	GD527	51.60	55.72
<b>STOP END</b>	 (internal)	GD550	19.61	21.29	
<b>ADJUSTABLE RAFTER ARM</b>		Side	AC78		7.65
		Top	AC77		7.65
Black only					
<b>PACKING SHIM</b>	 for use with fascia bracket	SC380	0.56		
<b>HEAVY DUTY LEAFGUARD</b>	 Length 1220mm	SL102	12.89		
Mill finish					
<b>COMPATIBLE FIXING SCREWS</b>					
Roundhead fascia bracket screw 32mm x No. 10 roundhead – Mill finish		SC201	0.17		

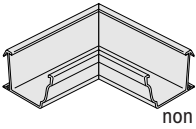
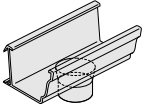

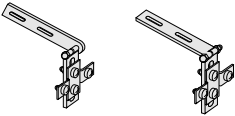

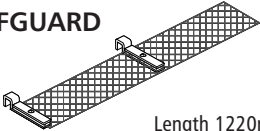
PPC = Polyester Powder Coated supplied to our standard range of colours. When ordering PPC prefix code by 'X' and state colour and RAL number – see inside front cover.

① = Please contact 01234 359438 for quote. ② = Brackets are concealed when fixed to typical fascia and therefore will be supplied plain unless otherwise stated.

Description		Code	Mill	PPC
<b>GUTTER</b> 155x100mm ogee system		1m	GG511	48.45
		2m	GG512	94.87
		3m	GG513	139.08
<b>UNION CLIP</b>	 (internal)	GG520	4.37	6.49
<b>FASCIA BRACKET</b>	 ②	GG580	1.52	2.60
<b>ANGLES</b>	 non std angle ①	90° int	GG530	44.26
		90° ext	GG531	44.26
		135° int	GG535	44.26
		135° ext	GG536	44.26
			GG539	POA
<b>OUTLET</b>		63mm Ø	GG522	33.60
		76mm Ø	GG523	36.24
		102mm Ø	GG524	44.59
		72x72mm	GG525	46.52
		102x76mm	GG526	50.64
		102x102mm	GG527	54.04
<b>STOP END</b>		Left Hand (int)	GG550	25.49
		Right Hand (int)	GG555	25.49
<b>ADJUSTABLE RAFTER ARM</b>		Side Top	AC78 AC77	7.65 7.65
Black only				
<b>PACKING SHIM</b>	 for use with fascia bracket	SC381	0.58	
<b>HEAVY DUTY LEAFGUARD</b>	 Length 1220mm	SL103	12.89	
Mill finish				
<b>COMPATIBLE FIXING SCREWS</b> Roundhead fascia bracket screw 32mm x No. 10 roundhead – Mill finish		SC201	0.17	

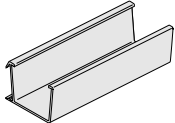
# RAINWATER SYSTEMS

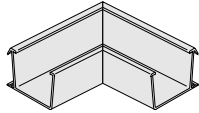
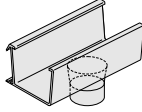

## Aligator® snap fit Boxer Gutter

Description	120 x 80mm			135 x 100mm			160 x 100mm			
	Code	Mill	PPC	Code	Mill	PPC	Code	Mill	PPC	
<b>GUTTER</b>										
	1m	GF411	21.60	30.43	GF511	32.17	43.22	GF611	34.16	46.14
	2m	GF412	41.85	59.49	GF512	63.03	85.88	GF612	66.98	90.99
	3m	GF413	60.82	87.28	GF513	92.58	125.60	GF613	98.57	134.62
<b>UNION CLIP</b>										
	(internal)	GF420	3.37	6.11	GF520	4.21	7.08	GF620	4.43	7.56
<b>FASCIA BRACKET</b>										
	②	GF480	1.45	2.57	GF080	1.52	2.60	GF080	1.52	2.60
<b>ANGLES</b>										
	90° int	GF430	28.36	34.00	GF530	37.47	43.31	GF630	39.80	45.57
	90° ext	GF431	28.36	34.00	GF531	37.47	43.31	GF631	39.80	45.57
	135° int	GF435	28.36	34.00	GF535	37.47	43.31	GF635	39.80	45.57
	135° ext	GF436	28.36	34.00	GF536	37.47	43.31	GF636	39.80	45.57
	non std angle ①	GF439	POA	POA	GF539	POA	POA	GF639	POA	POA
<b>OUTLET</b>										
	63mm Ø	GF422	24.93	29.09	GF522	27.08	32.39	GF622	27.32	33.69
	76mm Ø	GF423	24.93	29.09	GF523	27.08	32.39	GF623	27.32	33.69
	102mm Ø				GF524	40.56	45.85	GF624	40.68	47.06
	72x72mm	GF425	35.10	39.54	GF525	37.18	42.49	GF625	37.34	43.72
	102x76mm	GF426	42.03	46.85	GF526	44.37	49.68	GF626	44.46	50.83
	102x102mm				GF527	49.21	54.54	GF627	49.28	55.61
<b>STOP END</b>										
	Left hand (int)	GF450	16.09	18.09	GF550	20.53	22.61	GF650	22.47	24.77
	Right hand (int)	GF455	16.09	18.09	GF555	20.53	22.61	GF655	22.47	24.77

PPC = Polyester Powder Coated supplied to our standard range of colours. When ordering PPC prefix code by 'X' and state colour and RAL number – see inside front cover.



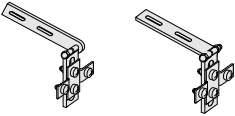

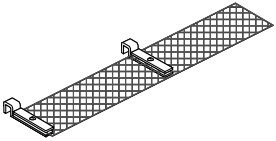
① = Please contact 01234 359438 for quote. ② = Brackets are concealed when fixed to typical fascia and therefore will be supplied plain unless otherwise stated.

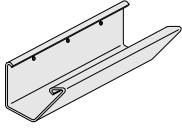

## Aligator® snap fit Boxer Gutter

Description	Code	Mill	Black
<p><b>ADJUSTABLE RAFTER ARM</b></p>  <p>Side Top</p> <p>Black only</p>	<p>AC78 AC77</p>		<p>7.65 7.65</p>
<p><b>PACKING SHIM</b></p>  <p>120x80mm 135x100, 160x100mm For use with fascia bracket</p>	<p>SC382 SC381</p>	<p>0.55 0.58</p>	
<p><b>HEAVY DUTY LEAFGUARD</b></p>  <p>120x80mm 135x100mm 160x100mm Length 1220mm</p> <p>Mill finish</p>	<p>SL105 SL106 SL107</p>	<p>12.89 12.89 12.89</p>	
<p><b>COMPATIBLE FIXING SCREWS</b></p> <p>Roundhead fascia bracket screw 32mm x No. 10 roundhead – Mill finish</p>	<p>SC201</p>	<p>0.17</p>	

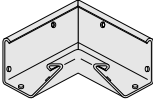
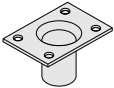
# RAINWATER SYSTEMS



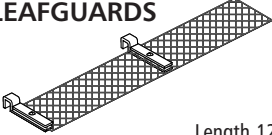



## Aligator® snap fit Giant

Description	Code	Mill	PPC
<b>GUTTER</b> 200x150mm  3m	<b>GH813</b>	<b>121.97</b>	<b>157.30</b>
<b>UNION CLIP</b>  (external)	<b>GH820</b>	<b>13.97</b>	<b>14.63</b>
<b>STIFFENER BRACKET &amp; SPACER ASSEMBLY</b>  4 stiffener brackets required to each 3m gutter length	<b>GH885</b>	<b>6.05</b>	
<b>ANGLES</b>  90° int <b>GH830</b> <b>68.33</b> <b>80.92</b> 90° ext <b>GH831</b> <b>68.33</b> <b>80.92</b> 135° int <b>GH835</b> <b>68.33</b> <b>80.92</b> 135° ext <b>GH836</b> <b>68.33</b> <b>80.92</b> non std angle ① <b>GH839</b> <b>POA</b> <b>POA</b>			
<b>PATCH OUTLET</b>  76mm Ø <b>GH823</b> <b>33.71</b> <b>36.82</b> 102mm Ø <b>GH824</b> <b>33.71</b> <b>36.82</b> 72x72mm <b>GH825</b> <b>33.71</b> <b>36.82</b> 102x76mm <b>GH826</b> <b>33.71</b> <b>36.82</b> 102x102mm <b>GH827</b> <b>33.71</b> <b>36.82</b>			
<b>STOP END</b>  (external) LH <b>GH850</b> <b>39.92</b> <b>44.74</b> (external) RH <b>GH855</b> <b>39.92</b> <b>44.74</b>			

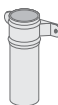
Description	Code	Mill	PPC
<p><b>HEAVY DUTY LEAFGUARDS</b></p>  <p>Mill finish <span style="float: right;">Length 1220mm</span></p>	SL225	15.59	
<p><b>COMPATIBLE FIXING SCREWS</b></p> <p>32mm x No. 10 countersunk – for use with union, angle and outlet 50mm x No. 12 domehead – for use with gutter</p>	SC202 SC231	0.17 0.27	
<p><b>ALUMINIUM WASHERS</b></p> <p>M6 x 15mm Aluminium washer per 100</p> 	SC521	7.53	

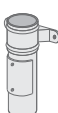

# RAINWATER SYSTEMS

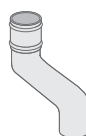

## Circular Downpipe Systems

Description	63mm			76mm			102mm			
	Code	Mill	PPC	Code	Mill	PPC	Code	Mill	PPC	
<b>PIPE</b> 	1m ③	RR211	29.84	33.91	RR311	33.13	38.19	RR411	48.85	56.70
	2m ③	RR212	41.08	50.42	RR312	45.76	56.87	RR412	68.78	86.05
	3m ③	RR213	49.15	63.97	RR313	55.42	72.74	RR413	85.30	112.32
	Available with non eared socket ③									
<b>LOOSE PIPE SOCKET</b> 	③	RR220	9.04	10.62	RR320	12.30	14.18	RR420	19.29	22.42
<b>BEND</b> 	Bend 92.5°	RR230	34.78	36.57	RR330	39.10	41.28	RR430	56.08	60.01
	Bend 112.5°	RR232	18.74	20.88	RR332	23.93	26.54	RR432	29.66	33.83
	Bend 135°	RR235	27.13	28.90	RR335	44.03	47.07	RR435	54.51	59.03
<b>BRANCHES</b> 	Branch 92.5°	RR240	38.92	41.13	RR340	44.72	47.87	RR440	60.13	65.35
	Branch 112.5°	RR242	37.22	41.13	RR342	44.72	47.87	RR442	60.13	65.35
	Branch 135°	RR245	38.92	41.13	RR345	44.72	47.87	RR445	57.26	65.35
<b>SHOE</b> 	③	RR250	12.97	14.33	RR350	17.92	20.47	RR450	23.67	27.76
<b>ACCESS PIPE</b> 	③	RR260	42.57	44.73	RR360	49.26	52.26	RR460	57.77	62.78
<b>PIPE CLIP</b> 	One Piece	RR280	6.35	7.58	RR380	6.42	7.91	RR480	7.50	8.95
<b>FIXED OFFSETS</b> 	75mm	RR2903	42.74	44.45	RR3903	52.58	54.90	RR4903	63.95	67.57
	100mm	RR2904	42.74	44.68	RR3904	52.58	55.15	RR4904	63.95	67.89
	150mm	RR2906	42.74	45.01	RR3906	52.58	55.58	RR4906	63.95	68.39
	225mm	RR2909	51.30	54.57	RR3909	62.26	67.35	RR4909	74.60	80.63
	300mm	RR2912	51.30	55.11	RR3912	63.09	68.09	RR4912	74.60	81.71
Non Standard Projections Available										

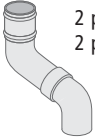
PPC = Polyester Powder Coated supplied to our standard range of colours. When ordering PPC prefix code by 'X' and state colour and RAL number – see inside front cover.



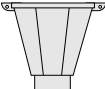
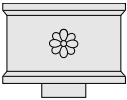





③ = If sockets required without ears add suffix NE to part number.

Description	63mm			76mm			102mm		
	Code	Mill	PPC	Code	Mill	PPC	Code	Mill	PPC
<b>ADJUSTABLE OFFSETS</b>  2 part adj to 450mm 2 part adj to 900mm  Non Standard Projections Available	RR2945	54.52	58.92	RR3945	67.06	72.49	RR4945	91.52	100.31
	RR2990	58.88	65.36	RR3990	75.24	83.22	RR4990	105.14	117.96
	Min Offset Achievable 150mm			Min Offset Achievable 200mm			Min Offset Achievable 160mm		
<b>RAINWATER DIVERTER KIT</b>  Complete with black pvc-u flexible pipe	RRD25	42.37	44.73	RRD35	47.09	49.44			

Description	Code	Mill	PPC
<b>HOPPERS</b>  Standard – 63mm Circular Standard – 76mm Circular Standard – 102mm Circular   Triangular Flat Back – 63 mm Circular Triangular Flat Back – 76 mm Circular   Ornamental – 63mm Circular Ornamental – 76mm Circular Ornamental – 102mm Circular	RH101	36.85	45.77
	RH102	38.54	47.49
	RH103	51.59	61.41
	RH201	25.75	35.37
	RH202	25.75	35.37
	RH301	173.42	187.87
	RH302	173.42	187.87
	RH303	173.42	187.87
	<b>PIPE SOCKET FILLER</b> Foam  10m roll	SC911	11.90
<b>CAST SPACER BOBBIN</b> 30mm projection  PPC Mill Finish	SC711 SC701	4.63	5.33
<b>COMPATIBLE FIXING SCREWS</b> 50mm x No. 16 domehead – for use with downpipe & hopper 50mm x No. 16 domehead – for use with downpipe & hopper 75mm x No. 16 hexagonal – for use with Cast spacer bobbin 75mm x No. 16 hexagonal – for use with Cast spacer bobbin	SC603 SC221 SC604 SC244	1.24 1.24 1.14	1.40 1.40

# RAINWATER SYSTEMS



## Square/Rectangular downpipe



Description	72 x 72mm			102 x 76mm			102 x 102mm			
	Code	Mill	PPC	Code	Mill	PPC	Code	Mill	PPC	
<b>PIPE</b> 	1m ③	RSR311	46.33	52.79	RSR111	58.52	66.39	RSR411	54.79	63.22
	2m ③	RSR312	65.36	80.44	RSR112	87.54	105.62	RSR412	80.23	99.55
	3m ③	RSR313	80.78	104.68	RSR113	112.80	141.39	RSR413	102.37	132.93
	Available with non eared sockets ③									
<b>LOOSE PIPE SOCKET</b> 	③	RSR320	15.59	17.67	RSR120	17.44	19.83	RSR420	17.68	20.88
<b>BEND</b> 	92.5°	RSR330	52.41	55.34	RSR130④	58.72	63.11	RSR430	58.13	61.72
	112.5°	RSR332	52.41	55.34	RSR132④	58.72	63.11	RSR432	58.13	61.72
	135°	RSR335	52.41	55.34	RSR135④	58.72	63.11	RSR435	58.13	61.72
	See note 4 for handling									
<b>BRANCHES</b> 	92.5°	RSR340	82.31	89.79	RSR140④	92.90	98.91	RSR440	90.94	95.53
	112.5°	RSR342	82.31	89.79	RSR142④	92.90	98.91	RSR442	90.94	95.53
	135°	RSR345	82.31	89.79	RSR145④	92.90	98.91	RSR445	90.94	95.53
	See note 4 for handling									
<b>SHOE</b> 	③	RSR350	52.41	54.34	RSR150	58.72	61.33	RSR450	58.13	61.32
<b>ACCESS PIPE</b> 	③	RSR360	59.40	62.25	RSR160	64.63	68.44	RSR460	61.07	65.71
<b>PIPE CLIP</b> 	Two piece	RSR380	9.18	9.89	RSR180	8.00	8.87	RSR480	8.22	9.44
<b>FIXED OFFSETS</b> 	75mm	RSR3903	65.34	67.97	RSR1903④	71.96	75.25	RSR4903	69.66	81.08
	100mm	RSR3904	65.99	68.63	RSR1904④	72.65	76.20	RSR4904	71.02	83.87
	150mm	RSR3906	66.56	69.95	RSR1906④	73.44	77.57	RSR4906	73.81	87.79
	225mm	RSR3909	67.61	71.73	RSR1909④	74.90	79.60	RSR4909	75.37	89.65
	300mm	RSR3912	68.80	73.64	RSR1912④	76.39	82.20	RSR4912	76.86	92.30
	Non Standard Projections Available									
See note 4 for handling										

PPC = Polyester Powder Coated supplied to our standard range of colours. When ordering PPC prefix code by 'X' and state colour and RAL number – see inside front cover.

③ = If sockets required without ears add suffix NE to part number. ④ = For 102 x 76mm state if different handling/projection is required, otherwise will be supplied as illustrated.

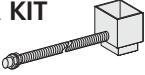

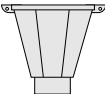
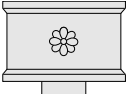





## Square/Rectangular downpipe

Description	72 x 72mm			102 x 76mm			102 x 102mm		
	Code	Mill	PPC	Code	Mill	PPC	Code	Mill	PPC
<b>ADJUSTABLE OFFSETS</b>									
 2 part adj to 450mm	RSR3945	90.98	95.87	RSR1945④	99.37	105.32	RSR4945	95.98	103.08
2 part adj to 900mm	RSR3990	95.83	104.05	RSR1990④	105.67	115.49	RSR4990	102.73	114.37
	See note 4 for handling								
Non Standard Projections Available	Min Offset Achievable 75mm			Min Offset Achievable 75mm			Min Offset Achievable 100mm		
<b>DRAIN CONNECTOR (SLIP SOCKET)</b>									
 RSR370	RSR370	55.89	57.71	RSR170	57.66	60.11	RSR470	59.42	62.71
Adapts to 110mm Circular									
<b>RAINWATER DIVERTER KIT</b>									
 RSRD35	RSRD35	54.14	56.50	RSRD15	61.20	63.57			
Complete with black pvc-u flexible pipe									

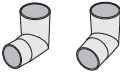



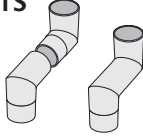





Description	Code	Mill	PPC
<b>HOPPERS</b>			
 Standard – 72x72mm	RH104	51.59	61.41
Standard – 102x76mm	RH105	51.59	61.41
Standard – 102x102mm	RH106	51.59	61.41
 Triangular Flat Back – 72x72mm	RH204	57.10	67.60
 Ornamental – 72x72mm	RH304	173.42	187.87
Ornamental – 102x76mm	RH305	173.42	187.87
Ornamental – 102x102mm	RH306	173.42	187.87
<b>CAST SPACER BOBBIN</b>			
 30mm projection	PPC SC711 Mill Finish SC701	4.63	5.33
<b>COMPATIBLE FIXING SCREWS</b>			
50mm x No. 16 domehead – for use with downpipe & hopper	SC603		1.40
50mm x No. 16 domehead – for use with downpipe & hopper	SC221	1.24	
75mm x No. 16 hexagonal – for use with Cast spacer bobbin	SC604		1.24
75mm x No. 16 hexagonal – for use with Cast spacer bobbin	SC244	1.14	

# RAINWATER SYSTEMS

## 76mm Flush-fit circular downpipe

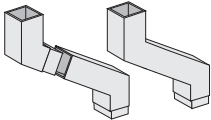

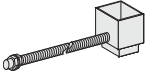
Description		Code	Heritage Black	PPC
<b>3M DOWNPIPE</b>		RE313	46.20	50.88
<b>LOOSE JOINT SPIGOT</b>		RE320	8.40	9.54
<b>BENDS</b>	 92.5° 112.5°	RE330 RE332	19.43 19.43	20.67 20.67
<b>BRANCH 112.5°</b>		RE342	36.75	38.16
<b>SHOE</b>		RE350	15.23	16.43
<b>ACCESS PIPE</b>		RE360	47.25	48.76
<b>PIPE CLIP</b>		RE380	3.68	3.98
<b>OFFSETS</b>	 2 part adj 90 to 250mm 2 part adj 90 to 500mm 2 part adj 90 to 1000mm Fixed	RE3925 RE3950 RE39100	42.00 44.50 49.50 POA	44.00 46.50 51.50 POA
<b>RAINWATER DIVERTER</b>		RED35	47.70	47.70
<b>HOPPER</b>		RH111	47.70	47.70
<b>COMPATIBLE FIXING SCREWS</b>	50mm x No. 12 domehead – For use with downpipe 50mm x No. 16 domehead – For use with hopper	SC605 SC603	0.39 1.40	0.39 1.40

## 72mm Flush-fit square downpipe



Description		Code	Heritage Black	PPC
<b>3M DOWNPIPE</b>		RJ313	76.00	82.00
<b>LOOSE JOINT SPIGOT</b>		RJ320	8.25	9.25
<b>BENDS</b>	 92.5° 112.5°	RJ330 RJ332	28.25 28.25	28.75 28.75
<b>BRANCH 112.5°</b>		RJ342	48.00	49.00
<b>SHOE</b>		RJ350	19.25	19.75
<b>ACCESS PIPE</b>		RJ360	34.00	35.00
<b>PIPE CLIP 72MM</b>	 Two piece	RJ380	8.00	9.00
<b>OFFSETS</b>	 2 part adj 75 to 250mm 2 part adj 75 to 500mm 2 part adj 75 to 1000mm Fixed	RJ3925 RJ3950 RJ39100	58.00 63.00 73.00 POA	59.00 64.00 74.00 POA
<b>DRAIN CONNECTOR (SLIP SOCKET)</b>		RJ370	56.70	56.70
<b>RAINWATER DIVERTER</b>		RJD35	56.50	56.50
<b>HOPPER</b>	 72 x 72mm	RH112	61.41	61.41
<b>COMPATIBLE FIXING SCREWS</b>	50mm x 12 roundhead – for use with downpipe 50mm x No. 16 domehead – for use with hopper	SC605 SC603	0.39 1.40	0.39 1.40

# RAINWATER SYSTEMS

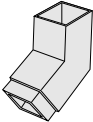
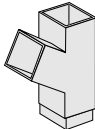
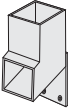
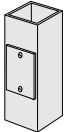
## Vandal resistant downpipe systems



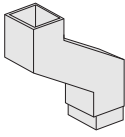
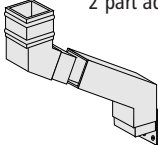



Description	72 x 72mm			102 x 76mm			102 x 102mm			
	Code	Mill	PPC	Code	Mill	PPC	Code	Mill	PPC	
<b>PIPE</b> 	1m	RVR311	47.70	54.30	RVR111	60.24	68.31	RVR411	56.36	65.05
	2m	RVR312	67.28	82.76	RVR112	90.06	108.71	RVR412	82.55	102.43
	3m	RVR313	83.11	107.71	RVR113	116.05	145.44	RVR413	105.34	136.77
<b>INTERNAL JOINT SPIGOT</b> 		RVR320	5.10	6.68	RVR120	5.99	7.28	RVR420	7.57	9.13
<b>BEND</b> 	92.5°	RVR330	53.92	56.95	RVR130④	60.41	64.95	RVR430	59.81	63.47
	112.5°	RVR332	53.92	56.95	RVR132④	60.41	64.95	RVR432	59.81	63.47
	135°	RVR335	53.92	56.95	RVR135④	60.41	64.95	RVR435	59.81	63.47
	Complete with fixing plate				See note 4 for handling					
<b>BRANCHES</b> 	92.5°	RVR340	68.66	70.67	RVR140④	73.94	77.48	RVR440	75.37	76.83
	112.5°	RVR342	68.65	74.20	RVR142④	77.62	81.37	RVR442	75.37	76.83
	135°	RVR345	65.38	74.20	RVR145④	73.94	77.48	RVR445	75.37	76.83
	Complete with fixing plate				See note 4 for handling					
<b>SHOE</b> 		RVR350	51.35	53.25	RVR150	57.55	60.11	RVR450	56.95	60.10
<b>ACCESS PIPE</b> 		RVR360	45.07	45.89	RVR160	48.56	50.04	RVR460	44.66	46.13

## Vandal resistant downpipe systems

Description	72 x 72mm			102 x 76mm			102 x 102mm		
	Code	Mill	PPC	Code	Mill	PPC	Code	Mill	PPC
<b>FIXING PLATE</b> 	RVR380	7.78	8.65	RVR180	8.23	9.14	RVR480	8.49	9.73
<b>WALL OFFSETS</b>  Complete with fixing plate Provide required dimensions with order (see design & installation guide)		POA	POA		POA	POA		POA	POA
<b>ADJUSTABLE EAVES OFFSETS</b>  2 part adj to 450mm 2 part adj to 900mm  Non Standard Projections Available	RVR3945 RVR3990	99.59 104.49	105.61 114.06	RVR1945 <sup>④</sup> RVR1990 <sup>④</sup>	109.04 115.40	116.24 126.46	RVR4945 RVR4990	105.67 110.73	114.52 125.92
				See note 4 for handing					
		Min Offset Achievable 75mm		Min Offset Achievable 75mm			Min Offset Achievable 100mm		
<b>DRAIN CONNECTOR (SLIP SOCKET)</b>  To 110mm Circular	RVR370	55.89	57.71	RVR170	57.66	60.11	RVR470	59.46	62.71
<b>COMPATIBLE FIXING SCREWS</b>  50mm x No. 12 Countersunk – for use with fixing plate	SC241	0.28							

# RAINWATER SYSTEMS

## Aligator® installation sundries

Description	Code	Price
<b>SEALANT</b>  310ml clear Please note sealant shelf life is 12 months	SC101	7.11
<b>SEALANT GUN</b> 	SC105	12.59
<b>SOLVENT CLEANER</b>  1 litre	SC108	23.26
<b>GUTTER JOINT COMPRESSION TOOL</b> 	SC104	14.17
<b>TOUCH UP PAINT</b>  250ml	SC880	29.04
<b>LIGHTNING CONDUCTOR</b>  Universal link assembly Oxide inhibitor 225cc	SC401 SC402	6.37 63.08

## Aligator® sealant usage table

Approximate number of joints per tube of Alutec sealant

Aligator® Deepflow .....	6	63mm dia. pipe socket .....	25
Aligator® No 46 Ogee .....	4	76mm dia. pipe socket .....	20
120 x 80mm Aligator® Boxer .....	5	102mm dia. pipe socket .....	15
135 x 100mm Aligator® Boxer .....	4	72 x 72mm pipe socket .....	17
160 x 100mm Aligator® Boxer .....	4	102 x 76mm pipe socket .....	13
Aligator® Giant .....	3	102 x 102mm pipe socket .....	12
Aligator® Classic .....	5	62 x 62mm pipe socket .....	20



310ml Tube of sealant = approximately 6 linear metres of 8mm diameter bead.



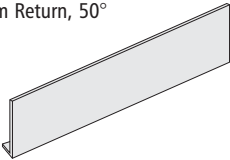
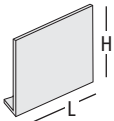

soffit & fascia

# SYSTEMS

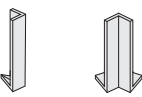
## Composite Aluminium Fascia Type 'A'



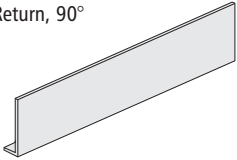
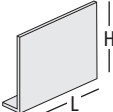

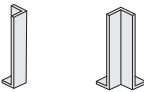
Description		Code	Price
<b>FASCIA A – 3m</b> ① 30mm Return, 50° 	150mm	FA1150	61.00
	175mm	FA1175	67.00
	210mm	FA1210	75.00
	260mm	FA1260	87.00
	340mm	FA1340	104.00
	460mm	FA1460	135.00
	Non standard sizes available on request ①		
<b>GABLE BOX END</b> 	L      H		
	450mm x 350mm	FA51	27.50
	600mm x 350mm	FA52	32.50
	600mm x 650mm	FA53	51.50
Site cut as required			
<b>FASCIA JOINT COVER STRIP</b> 	210mm	FA21	3.00
	340mm	FA22	4.50
	460mm	FA23	5.50
	Site cut as required		
<b>FASCIA CAP END</b> 	LH 210mm	FA3210	13.00
	LH 340mm	FA3340	13.25
	LH 460mm	FA3460	13.50
	RH 210mm	FA4210	13.00
	RH 340mm	FA4340	13.25
	RH 460mm	FA4460	13.50
	Left hand shown		
<b>CORNER TRIMS</b> 	external 210mm	FA6210	4.00
	external 340mm	FA6340	5.55
	external 460mm	FA6460	7.00
	internal 210mm	FA7210	6.50
	internal 340mm	FA7340	8.00
	internal 460mm	FA7460	9.50

## Composite Aluminium Fascia Type 'B'

Description		Code	Price
<b>FASCIA B – 3m</b> 30mm Return, 90° 	160mm	FB1160	66.00
	190mm	FB1190	73.00
	225mm	FB1225	81.00
	270mm	FB1270	91.00
	350mm	FB1350	108.00
	470mm	FB1470	138.00
	Non standard sizes available on request ①		
<b>GABLE BOX END</b> 	L H		
	450mm x 350mm	FB51	27.50
	600mm x 350mm	FB52	32.50
	600mm x 650mm	FB53	51.50
Site cut as required			
<b>FASCIA JOINT COVER STRIP</b> 	225mm	FB21	3.00
	350mm	FB22	4.50
	470mm	FB23	5.50
	Site cut as required		
<b>FASCIA CAP END</b> 	LH 225mm	FB3225	13.50
	LH 350mm	FB3350	13.75
	LH 470mm	FB3470	14.00
	RH 225mm	FB4225	13.50
	RH 350mm	FB4350	13.75
	RH 470mm	FB4470	14.00
	Left hand shown		
<b>CORNER TRIMS</b> 	external 225mm	FB6225	4.00
	external 350mm	FB6350	5.50
	external 470mm	FB6470	7.00
	internal 225mm	FB7225	6.50
	internal 350mm	FB7350	8.00
	internal 470mm	FB7470	9.50

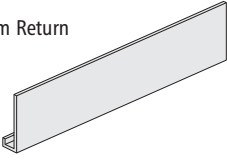
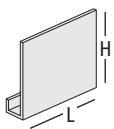
# SYSTEMS

## Composite Aluminium Fascia Type 'C'

Description		Code	Price
<b>FASCIA C – 3m</b> ①			
30x25mm Return 	165mm	FC1165	74.00
	200mm	FC1200	83.50
	255mm	FC1255	94.50
	330mm	FC1330	113.50
	450mm	FC1450	141.50
Non standard sizes available on request ①			
<b>GABLE BOX END</b>			
	L H		
	450mm x 350mm	FC51	28.50
	600mm x 350mm	FC52	34.50
600mm x 650mm	FC53	53.50	
Site cut as required			
<b>FASCIA JOINT COVER STRIP</b>			
	200mm x 35mm	FC21	3.00
	330mm x 35mm	FC22	4.50
	450mm x 35mm	FC23	5.50
Site cut as required			
<b>FASCIA CAP END</b>			
	LH 225mm	FB3225	13.50
	LH 350mm	FB3350	13.75
	LH 470mm	FB3470	14.00
	RH 225mm	FB4225	13.50
	RH 350mm	FB4350	13.75
	RH 470mm	FB4470	14.00
Left hand shown			
<b>CORNER TRIMS</b>			
	external 225mm	FB6225	3.75
	external 350mm	FB6350	5.25
	external 470mm	FB6470	6.75
	internal 225mm	FB7225	6.25
	internal 350mm	FB7350	7.75
	internal 470mm	FB7470	9.25

## Composite Aluminium Universal Soffit System

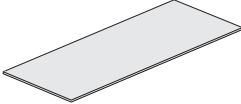
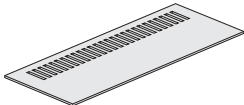
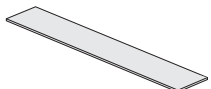
Description	Code	Price
<b>SOFFIT PANEL UNVENTED – 3m</b>		
	110mm FF1110	31.50
	190mm FF1190	49.50
	255mm FF1255	66.50
	310mm FF1310	78.50
	380mm FF1380	95.50
	510mm FF1510	124.50
	775mm FF1775	181.50
Non standard sizes available on request ①		
<b>SOFFIT PANEL VENTED – 3m</b>		
	110mm FV1110	42.50
	190mm FV1190	62.50
	255mm FV1255	77.50
	310mm FV1310	89.50
	380mm FV1380	106.50
	510mm FV1510	137.50
	775mm FV1775	198.50
*Slotted to give 20mm continuous ventilation area Non standard sizes available on request ①		
<b>JOINT COVER STRIP</b>		
	200mm FF21	3.00
	400mm FF22	4.50
	600mm FF23	6.00
	800mm FF24	7.50
Site cut as required		
<b>INSTALLATION SUNDRIES</b>		
Polypin – 14 swg (2mm) x 30mm A4 – Bag 100 (colour matched)	SC670	54.50
Anular nail – 3.00 x 50mm A4 (100 per bag) (fixing fascia where gutter will hide fixings)	SC280	78.50
No 10 x 15mm roundhead Pozi fixing A4 (100 per bag) (for fixing gutter brackets to fascia)	SC203	32.00
MS polymer sealant 310cc	SC110	7.11
Silicone sealant (colour matched)	SC103	15.00

# SYSTEMS

## Composite Aluminium Wall Coping Range

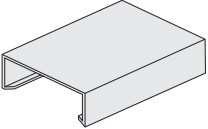
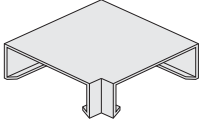
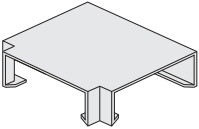
Description	Compatible Wall Thickness	Coping Width	Code	Price
<b>COPING – 3m</b> * 60mm turn downs 	90 to 125mm	185mm	FG1185	111.15
	126 to 185mm	245mm	FG1245	124.48
	186 to 240mm	300mm	FG1300	136.71
	241 to 305mm	365mm	FG1365	151.16
	306 to 360mm	420mm	FG1420	163.39
	361 to 420mm	480mm	FG1480	204.54
	421 to 480mm	540mm	FG1540	223.08
	481 to 535mm	595mm	FG1595	256.91
	536 to 605mm	665mm	FG1665	276.63
Non standard sizes available on request ①				
<b>ANGLE 90°</b> 	90 to 125mm	185mm	FG3185	56.76
	126 to 185mm	245mm	FG3245	66.48
	186 to 240mm	300mm	FG3300	77.70
	241 to 305mm	365mm	FG3365	91.37
	306 to 360mm	420mm	FG3420	108.83
	361 to 420mm	480mm	FG3480	174.03
	421 to 480mm	540mm	FG3540	202.96
	481 to 535mm	595mm	FG3595	234.10
	536 to 605mm	665mm	FG3665	267.42
<b>T-JUNCTION</b> 	90 to 125mm	185mm	FG2185	67.43
	126 to 185mm	245mm	FG2245	76.63
	186 to 240mm	300mm	FG2300	87.23
	241 to 305mm	365mm	FG2365	100.61
	306 to 360mm	420mm	FG2420	118.14
	361 to 420mm	480mm	FG2480	183.50
	421 to 480mm	540mm	FG2540	212.01
	481 to 535mm	595mm	FG2595	242.60
	536 to 605mm	665mm	FG2665	275.36

## Composite Aluminium Wall Coping Range

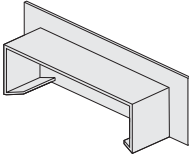
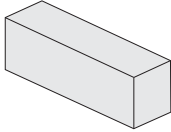
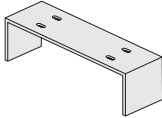
Description	Compatible Wall Thickness	Coping Width	Code	Price
<b>STOP END UPSTAND</b>				
	90 to 125mm	185mm	FG5185	40.96
	126 to 185mm	245mm	FG5245	43.53
	186 to 240mm	300mm	FG5300	46.97
	241 to 305mm	365mm	FG5365	51.14
	306 to 360mm	420mm	FG5420	56.93
	361 to 420mm	480mm	FG5480	81.20
	421 to 480mm	540mm	FG5540	88.72
	481 to 535mm	595mm	FG5595	96.22
	536 to 605mm	665mm	FG5665	103.73
<b>STOP END</b>				
	90 to 125mm	185mm	FG6185	37.69
	126 to 185mm	245mm	FG6245	40.43
	186 to 240mm	300mm	FG6300	43.16
	241 to 305mm	365mm	FG6365	46.59
	306 to 360mm	420mm	FG6420	51.84
	361 to 420mm	480mm	FG6480	72.02
	421 to 480mm	540mm	FG6540	78.62
	481 to 535mm	595mm	FG6595	85.10
	536 to 605mm	665mm	FG6665	91.70
<b>FIXING BRACKET</b>				
	90 to 125mm	185mm	FG7185	10.06
	126 to 185mm	245mm	FG7245	10.06
	186 to 240mm	300mm	FG7300	10.06
	241 to 305mm	365mm	FG7365	10.45
	306 to 360mm	420mm	FG7420	11.65
	361 to 420mm	480mm	FG7480	12.90
	421 to 480mm	540mm	FG7540	14.11
	481 to 535mm	595mm	FG7595	15.31
	536 to 605mm	665mm	FG7665	16.51
* 80mm Wide				
<b>MS POLYMER SEALANT 310CC</b>			SC110	7.11

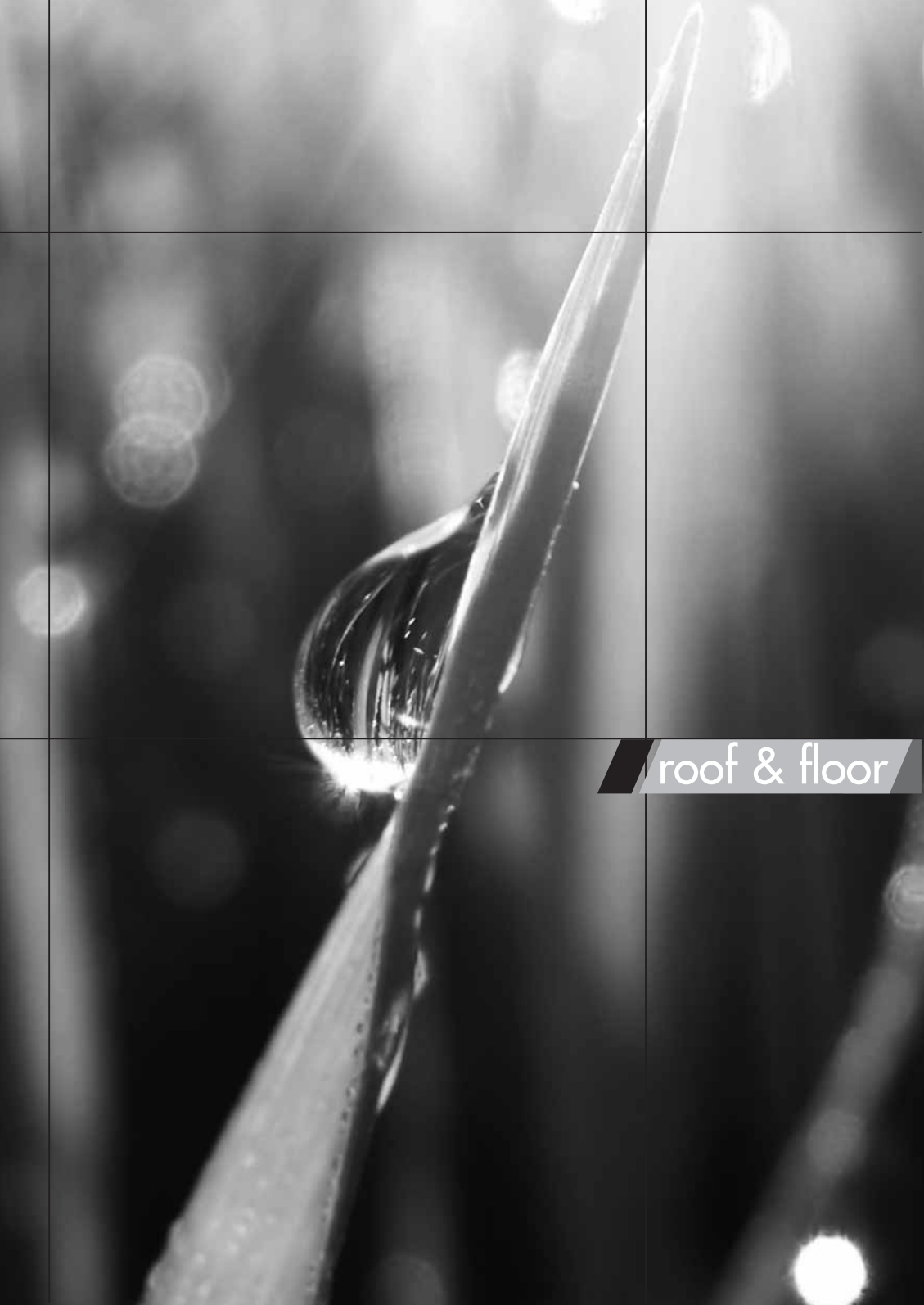



roof & floor

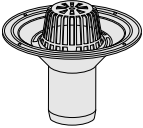
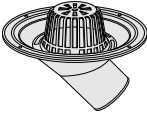
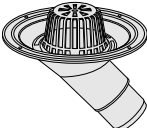
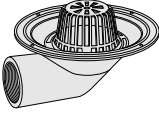
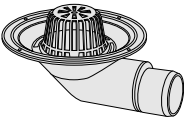



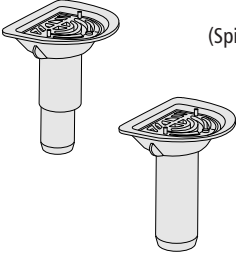
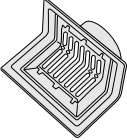

## Roof Outlets

Description	50mm		75mm		100mm		150mm		
	Code	Price	Code	Price	Code	Price	Code	Price	
<b>VERTICAL THREADED</b>									
	Dome	DR215	132.27	DR315	110.75	DR415	147.56	DR615	184.95
	Flat	DR215F	132.27	DR315F	110.75	DR415F	147.56	DR615F	184.95
<b>VERTICAL SPIGOT</b>									
	Dome	DR210	80.26	DR310	91.62	DR410	118.28	DR610	132.37
	Flat	DR210F	80.26	DR310F	91.62	DR410F	118.28	DR610F	132.37
<b>45° THREADED</b>									
	Dome	DR225	223.48	DR325	223.48	DR425	258.23		
	Flat	DR225F	223.48	DR325F	223.48	DR425F	258.23		
<b>45° SPIGOT</b>									
	Dome	DR220	155.20	DR320	162.65	DR420	194.93		
	Flat	DR220F	155.20	DR320F	162.65	DR420F	194.93		
<b>90° THREADED</b>									
	Dome	DR235	121.67	DR335	122.92	DR435	165.13	DR635	332.73
	Flat	DR235F	121.67	DR335F	122.92	DR435F	165.13	DR635F	332.73
<b>90° SPIGOT</b>									
	Dome	DR230	110.75	DR330	119.80	DR430	152.71		
	Flat	DR230F	110.75	DR330F	119.80	DR430F	152.71		

# SYSTEMS





## Roof Outlets

Description	50mm		75mm		100mm		150mm	
	Code	Price	Code	Price	Code	Price	Code	Price
<b>BALCONY OUTLET</b>  (Spigot)	DR260	81.43	DR360	87.27	DR460	97.16		
<b>SHALLOW BALCONY OUTLET</b>  (Spigot)	DR265	81.43	DR365	87.27				
<b>TWO-WAY OUTLET</b>  (Threaded)	DR250	91.62	DR350	95.99	DR450	97.16		
<b>CAR PARK OUTLET</b>  (Threaded)					DR480	207.96		
<b>GULLY OUTLET</b>  (Spigot)			DR370	130.53	DR470	123.70		



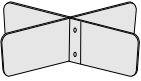

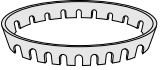

Description	50mm		75mm		100mm		150mm	
	Code	Price	Code	Price	Code	Price	Code	Price
<b>REFURBISHMENT ADAPTOR</b>  enables 75mm dia spigot to push into existing 100mm dia outlet			DRH8	4.95				
<b>THREADED ADAPTORS</b>  500mm max	DRA2	19.38	DRA3	24.54	DRA4	32.29	DRA6	56.82
<b>EXTENSION RING†</b>  125mm max	DRE3	40.68	DRE3	40.68	DRE4	40.68	DRE4	40.68
<b>EXTENSION RING†</b>  Balcony Outlet 117mm max	DRE6	68.44	DRE6	68.44	DRE6	68.44		
<b>EXTENSION RING†</b>  Gully Outlet 125mm max			DRE7	68.44	DRE7	68.44		
<b>TERRACE GRATE†</b>  230 x 230mm	DRG8	30.13	DRG8	30.13	DRG8	30.13	DRG8	30.13

# SYSTEMS

## Roof Outlet Accessories

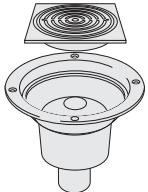
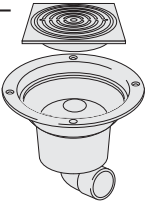

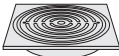

Description	50mm		75mm		100mm		150mm	
	Code	Price	Code	Price	Code	Price	Code	Price
<b>ANTI-VORTEX FINS</b>   Dome grate not included	DRH6	17.88	DRH6	17.88	DRH7	19.86	DRH7	19.86
<b>GRATES</b>  Dome	DRG1	24.11	DRG1	24.11	DRG2	24.86	DRG2	24.86
 Flat	DRG3	22.60	DRG3	22.60	DRG4	33.15	DRG4	33.15
<b>CLAMPING RING</b> 	DRC1	22.60	DRC1	22.60	DRC2	25.61	DRC2	25.61
<b>RAISING RING</b>  Car Park Outlet					DRE1	28.63		

Aluminium Shower Outlets

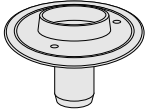
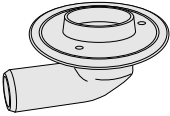

Description	40mm	
	Code	Price
<b>VERTICAL OUTLET – SHEET FLOORING</b>    Includes clamp and trap set	DF210	85.40
<b>HORIZONTAL OUTLET – SHEET FLOORING</b>    Includes clamp and trap set	DF215	85.40
<b>VERTICAL OUTLET – TILED FLOOR</b>    Includes clamp and trap set	Nickel Bronze grate DF230 Stainless Steel grate DF232	166.88 104.21
<b>HORIZONTAL OUTLET – TILED FLOOR</b>    Includes clamp and trap set	Nickel Bronze grate DF235 Stainless Steel grate DF237	166.88 104.21
<b>BLANKING PLATE FOR SHEET FLOOR</b>    DFB230	POA	
<b>TILE GRATE</b>   Nickel Bronze DF230T 89.51   Stainless Steel DF250T 26.86		

# SYSTEMS

## Aluminium Floor Outlets

Description	75mm		100mm	
	Code	Price	Code	Price
<b>VERTICAL SPIGOT UNTRAPPED</b> 	DF310	54.73		
<b>HORIZONTAL SPIGOT UNTRAPPED</b> 	DF315	58.94		
<b>HORIZONTAL SPIGOT TRAPPED</b>  <p style="text-align: right;">Includes dip tube</p>	DF330	104.20	DF430	104.20
<b>HORIZONTAL SPIGOT TRAPPED</b>  <p style="text-align: right;">2 x 2" BSP BOSS Includes dip tube &amp; One blanking plug</p>	DF335	114.72	DF435	114.72
<b>45° SPIGOT TRAPPED</b>  <p style="text-align: right;">Includes dip tube</p>	DF340	88.41		
<b>45° SPIGOT TRAPPED</b>  <p style="text-align: right;">2 x 2" BSP BOSS Includes dip tube &amp; One blanking plug</p>	DF345	91.57		

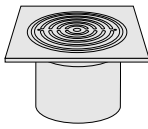
Nickel Bronze Grate Assemblies

Description	150mm		200mm	
	Code	Price	Code	Price
<p><b>CIRCULAR GRATE</b></p>  <p>150mm Spigot</p> <p>Spigot = PVCu cut to size</p>	DFG12	64.20		
<p><b>SQUARE TILE GRATE</b></p>  <p>150mm Spigot</p> <p>Spigot = PVCu cut to size</p>	DFG22	85.25	DFG32	111.57
<p><b>SHEET FLOORING GRATE</b></p>  <p>150mm Spigot ⑤</p> <p>Spigot = PVCu cut to size</p>			DFG42	114.72

# GENERAL INFORMATION

---

All list prices are for single components unless marked.

This price list does not constitute an offer. All prices are subject to change without notice and are exclusive of VAT. A sum equivalent to the VAT chargeable will be invoiced for payment by the customer. Customer attention is drawn to the Company's official Terms and Conditions of Sale. Goods are supplied strictly in accordance with these terms and conditions, copies of which are freely available on request.

Note:

Alutec products are manufactured to a constant high standard. Marley Plumbing & Drainage will not therefore accept responsibility for failure of any installation which includes components not supplied by us.

Roof Outlets are manufactured in Aluminium. Grates and clamp rings or flanges are Polyester Powder Coated.

Floor and Shower outlets are manufactured in Aluminium except where stated. Floor and Shower outlets are Polyester Powder Coated.

# IMPORTANT

---

Before despatching your order please check that you have ordered the appropriate amount of Sealant, Solvent Cleaner, Screws, Nuts/Bolts/Washers and Touch-up Paints. Where applicable when ordering, please clearly quote the colour and the RAL Code.

# NOTES

---



#### Further information

For technical enquiries please call **01234 344108**  
For general enquiries please call **01234 359438**  
email: [enquiries@marleyalutec.co.uk](mailto:enquiries@marleyalutec.co.uk)

Unit 1 (G-H), Viking Industrial Park, Hudson Road,  
Elms Farm Industrial Estate, Bedford MK41 0LZ  
Fax: +44 (0)1234 357199



#### Scotland

Birkenshaw Industrial Estate,  
Uddingston, Glasgow G71 5PA  
Telephone: **01698 815231** Fax: **01698 810307**

#### Export Division

Lenham, Maidstone, Kent ME17 2DE England  
Telephone: **+44 (0)1622 858888**  
Fax: **+44 (0)1622 850778**